



Manufacturers Since 1907

BUYER'S GUIDE 2014

AMERICA'S FINEST
MATERIAL HANDLING &
STORAGE EQUIPMENT

100⁺
Celebrating
YEARS OF
Quality • Integrity • Service



WE NEVER MISS!

A PROMISED SHIPPING DATE

MODERN EQUIPMENT COMPANY, INC.

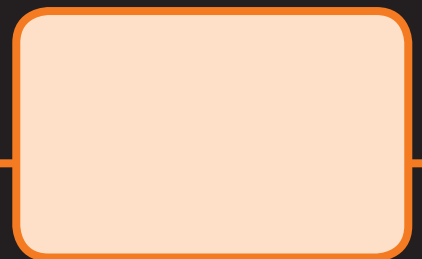



MODERN EQUIPMENT COMPANY, INC.

MANUFACTURERS OF AMERICA'S FINEST MATERIAL HANDLING & STORAGE EQUIPMENT

SINCE 1907

MECO OMAHA IS RELIABLE

- We never miss a promised shipping date—you can depend on *MECO OMAHA*
- *MECO OMAHA* sells only to dealers and distributors—overseas representation welcome
- Full two year warranty against defects—repair or replacement • **ANY** alteration to a *MECO OMAHA* product voids all warranties • *MECO OMAHA* is not responsible for the performance of any product which is improperly installed or improperly used • All rack must be installed and used in accordance with written instructions and specifications provided by *MECO OMAHA* • We do not install any product
- All welded steel construction
- Gray enamel finish used on cantilever rack • Orange enamel finish used on all other products unless otherwise specified in Buyer's Guide

MECO OMAHA IS EASY TO DO BUSINESS WITH

- Prompt shipments
- No minimum order—every order regardless of size receives personal attention
- To modify any *MECO OMAHA* product to fit your special requirements—call 1-800-228-7334 and ask us to quote • Quotation requests are answered promptly and carefully—price and delivery
- A variable steel surcharge may be applicable
- Drop shipments at no extra charge
- It is the consignee's responsibility to note "short shipments" or merchandise damaged in transit by the carrier before signing for the delivery

MECO OMAHA is not responsible for short shipments due to loss by the carrier and/or damage in transit
Freight quotations are estimates and are not binding on *MECO OMAHA*

- Weights included herein do not include pallets or packaging
- Terms: 1%—10 days, net 30 days, FOB our plant • 20% rehandling charge required on equipment returned in **saleable** condition, unless we made an error • **ANY** alteration to a *MECO OMAHA* product renders that product **unsaleable** • Such product cannot be returned for credit
- Visa® and MasterCard® accepted for net invoice amount
- Special orders may require some or all cash in advance • Normal terms for special orders are 1/3 of total invoice amount due when order is placed and specifications approved, 1/3 due before order is shipped and final 1/3 due 30 days after each shipment, subject to credit approval • Special orders are not returnable for credit
- *MECO OMAHA* is constantly striving to improve the quality of our products. As such, we may change specifications, alter designs or discontinue models at any time without notice or obligation
- All products are made in the U.S.A.

SATISFACTION GUARANTEED • WE'RE NOT SATISFIED UNTIL OUR CUSTOMER IS SATISFIED





MECO OMAHA CANTILEVER RACK

SERIES 1000 THROUGH SERIES 5000

• MECO OMAHA CANTILEVER RACK FOR A NEAT AND ORDERLY INVENTORY SYSTEM



- INSTANT ACCESSIBILITY TO ONE PIECE OR A FULL LOAD
- FAST, CONVENIENT HANDLING OF LONG, UNWIDELY STOCK

FOR STORAGE AND EASY SELECTION OF BAR STOCK, PIPE, STRUCTURALS, TUBING AND OTHER LONG ITEMS OR WHERE UNINTERRUPTED DECKING IS REQUIRED.

MECO OMAHA manufactures five basic capacity series to fit your storage requirements – from Series 1000 Medium Duty through the Series 5000 Extra Heavy Duty.

Available in upright heights from 6' to 20' with 2' through 10' brace widths (measured on center). Arms are completely adjustable on 3" centers to accommodate an infinite variety of items. Straight arms are available in nine different lengths with or without lips. Heavy Duty and Extra Heavy Duty arms are both available in seven lengths with or without lips. Inclined arms are available in seven lengths with or without lips. A wide range of base sizes allows custom designing of rack systems to your individual needs. Uprights are punched on both sides for versatility and can be used single sided or double sided depending on the size of base used. Note that arms must never be placed on the back side of a single-based upright.

MECO OMAHA CANTILEVER RACKS are modular within each basic capacity series so that additional arms, uprights and cross braces may be ordered at any time to add to your existing system. Different sized arms may be interchanged on racks to further tailor your racks to different uses. Standard and Heavy Duty arms (page 28) are designed for use on Series 3000, Series 4000 and Series 5000 uprights only. Series 1000 and Series 2000 components are not interchangeable with any other rack series.

Single sided uprights can be converted to doubles when used with longer bases designed to accommodate placement of arms on both sides. Upright capacities can be computed by multiplying the number of arms per upright by the individual arm capacities—NOT TO EXCEED TOTAL UPRIGHT CAPACITIES LISTED. Arm capacity is based on EVEN DISTRIBUTION OF LOAD. All racks are designed for quick assembly and come with complete instructions and hardware for installation.

Completely adjustable MECO OMAHA CANTILEVER RACKS eliminate storage problems. Heavy duty steel construction permits storage of tubes, bars, structurals and other long heavy items that must be kept off the floor. Bases can be used for extra storage. Forklift easily loads off and on arms and bases. Fast, convenient handling of heavy, long unwieldy stock. Instant accessibility to one piece or a full load. For longer materials, simply add braces and uprights to fit your requirements.

Specially designed MECO OMAHA CANTILEVER RACK systems may be required to meet your needs. MECO OMAHA representatives will work with you to develop the most feasible and economical rack system for your special situation. Special label requirements can be met at an additional cost. Ask us to quote prices and specifications for rack systems not covered in the MECO OMAHA BUYER'S GUIDE.

DETAILED SPECIFICATIONS ARE SET FORTH ON THE FOLLOWING PAGES

DESCRIPTION	UPRIGHT HEIGHTS	PAGE NO.
Series 1000 Medium Duty	6', 7', 8', 10', 12'	24
Series 2000 Medium-Heavy Duty	8', 10', 12', 14', 16', 18', 20'	25
Series 3000 Heavy Duty	8', 10', 12', 14', 15', 16', 18', 20'	26
Series 4000 Standard Heavy Duty	8', 10', 12', 14', 15', 16', 18', 20'	27
Series 5000 Extra Heavy Duty	12', 14', 15', 16', 18', 20'	28
Series 1000 Starter and Add-on Units	6', 8', 10'	29
Series 4000 Starter and Add-on Units	8', 10', 12'	29

Standard color for all cantilever rack components is gray. Custom colors available at additional cost.



WHAT IS CANTILEVER RACK?

Cantilever Rack is a freestanding storage unit with horizontal load carrying arms extending outward from a single vertical column. The absence of a vertical support on the outboard ends of the arms permits uninterrupted storage of long lengths of material.

Cantilever Rack is the **ideal system for storing furniture, steel bars, pipe and tubing, lumber and other long, heavy items** that must be kept off the floor...provides instant accessibility to one piece or a full load. Forklift easily loads off and on arms and bases. Being modular in nature, additional arms, uprights and braces may be added as storage requirements change.

Cantilever Rack is comprised of three components:

- Uprights
- Arms
- Brace Sets

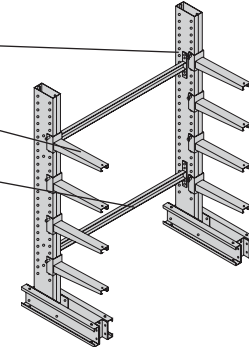

These components must be ordered in the appropriate quantities and capacities.

UPRIGHTS

Uprights consist of a vertical column and a horizontal base which is bolted to the column. A minimum of two uprights must be ordered to form a storage bay. Each edge of the column is punched vertically on 3" centers so it may be used as

a single or double sided upright depending on the size of base used. **NOTE:** The arms must never be placed on the back side of a single sided upright and base. Standard upright and base color is gray.

Single Sided Upright

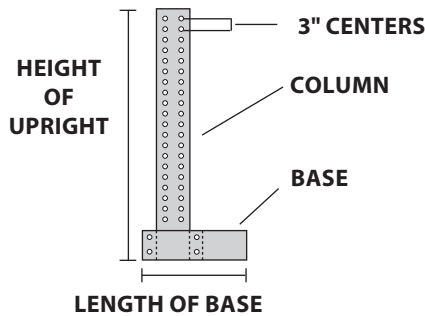

Holes are provided in the base to anchor the upright to the floor. Uprights must never be attached to walls, columns or other structures.

Double Sided Upright

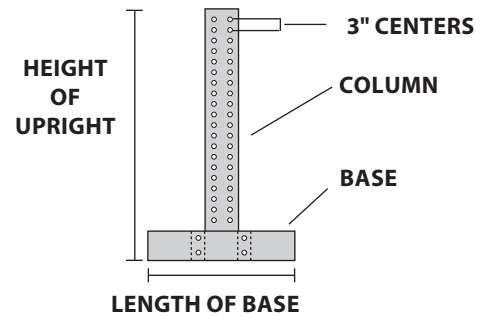

ARMS

Cantilever Arms are the heart of the rack system. Proper selection can make or break a successful storage plan. **MECO OMAHA** offers straight arms (generally used for storing stable loads such as lumber, steel sheets, cartons and skids) and inclined arms (for cylindrical objects or loads that tend to roll forward). Arms can be adjusted

on 3" centers up and down the upright and are available in lengths to 60" in a variety of capacities. The hair pin keeper permits instant adjustability and is easily inserted and removed for adjustment of arm height. Lips are available on all **MECO OMAHA** arms. Standard arm color is gray.

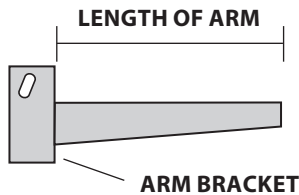

Straight Arm

Straight arms up to 48" long have a minimum pitch of 3/8" per foot to compensate for deflection. 54" and 60" arms have a minimum pitch of 5/8" per foot.

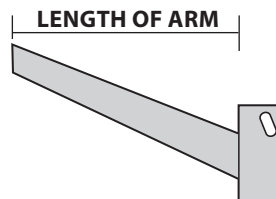

Inclined Arm

Inclined arms have a pitch of 20° or approximately 4.36" per foot.



MECO OMAHA
Hair Pin Keeper



BRACE SETS

Braces are structural channel members that are bolted between pairs of uprights to provide lateral stability to the rack system. X-bracing is utilized to increase the lateral stability of the taller (15' to 20') uprights. Brace

lengths are measured from centerline of upright to centerline of the next upright and are sold in sets rather than individual pieces. Standard brace color is gray.

Standard MECO OMAHA Brace Patterns

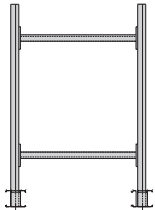

"2B" Horizontal Brace Pattern
Used on 6' to 10' Series 1000 uprights and 8' Series 2000, Series 3000 and Series 4000 uprights.

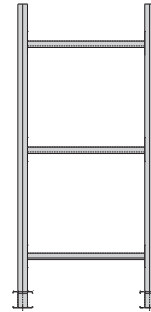

"3B" Horizontal Brace Pattern
Used on 12' Series 1000 uprights, 10' to 14' Series 2000, Series 3000 and Series 4000 uprights and 12' to 14' Series 5000 uprights.

"4BX" Horizontal Brace Pattern
Used on 16' to 20' Series 2000 uprights, 15' to 20' Series 3000, Series 4000 and Series 5000 uprights and all structural cantilever rack.

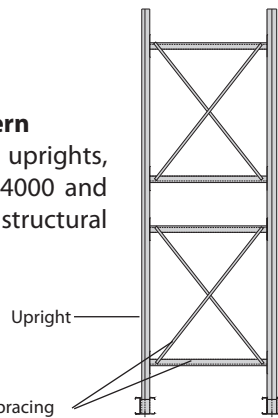

"4BXX" Horizontal Brace Pattern
Used on all 15' to 20' uprights when the brace length exceeds 84" centerline to centerline of upright.

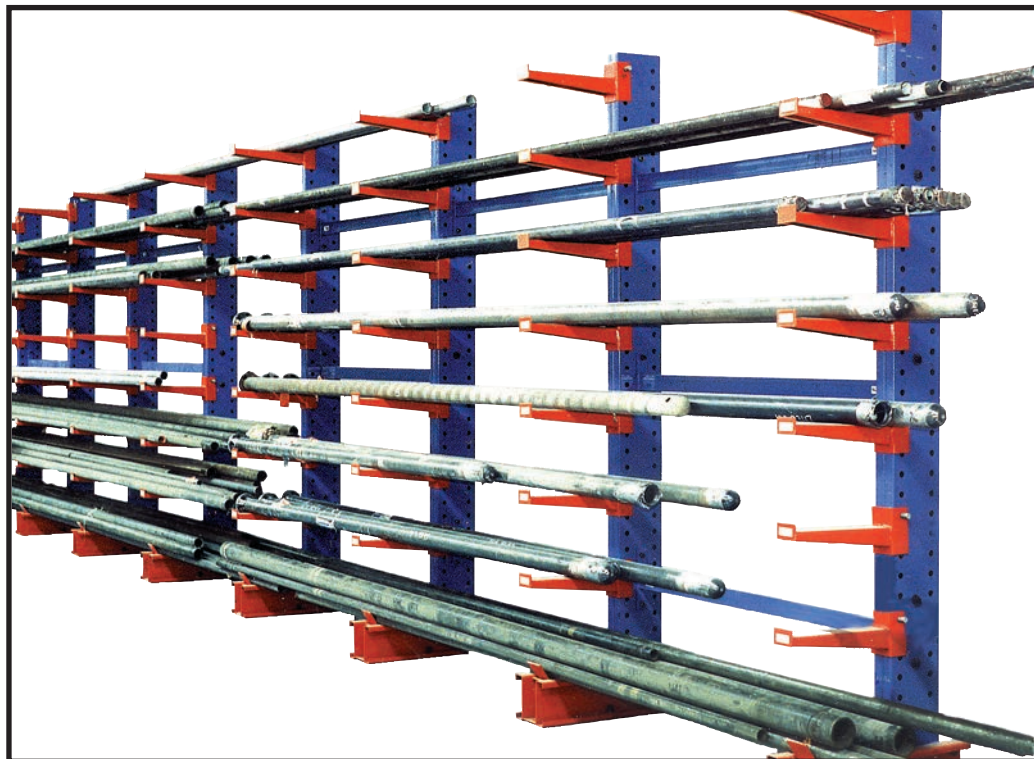
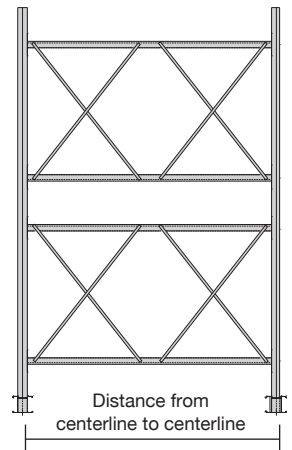

MECO OMAHA cantilever rack application consisting of uprights, arms and braces.

Standard color for all cantilever rack components is gray. Custom colors available at additional cost.



DESIGNING A CANTILEVER RACK SYSTEM

The key to a successful cantilever rack system is the answer to one question: **What is the product (load) being stored?** The answer must include the **length, depth, height** and

weight of the product. Once this data is ascertained it becomes a simple matter to determine the required arms, uprights and braces.

A. DETERMINE THE NUMBER AND SPACING OF ARMS

The load must be supported by enough arms to prevent load deflection. Deflection may cause damage to the load being stored as well as the arms (figure A1). To detect deflection, place the load over two wooden blocks (to represent cantilever arms) as shown in figure A2. If deflection is not present it is acceptable to use a two arm system as long as this does not create an overload

condition. If the load shows deflection use three blocks as shown in figure A3 or four blocks as in figure A4.

IMPORTANT: The load should overhang the end arms by one-half the distance from upright centerline to upright centerline. Failure to observe this measure may cause an overload condition on the arms.

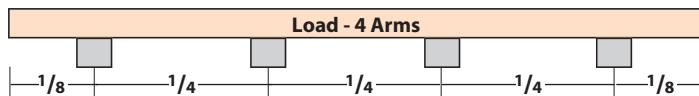
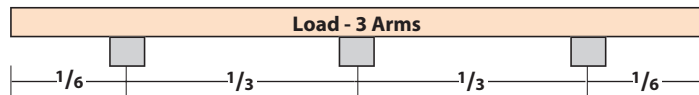
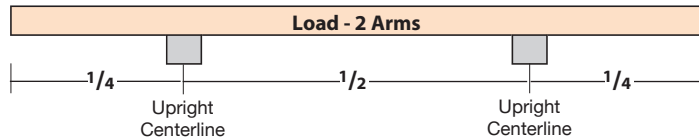
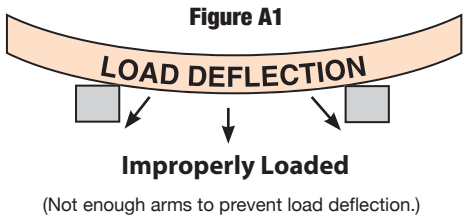

Figure A2

Figure A3

Figure A4

Adhering to these guidelines will ensure that each arm supports an equal amount of the load's weight.

B. DETERMINE THE LENGTH OF THE ARMS

The depth of the load should never exceed the length of the arm. A 48" wide bundle of plywood requires a 48" long arm, bundles of steel 24" wide require a 24" arm and so on. Rated

arm capacities may be seriously diminished if proper loading techniques are not observed. Figures B1, B2 and B3 illustrate correct and incorrect arm loading.

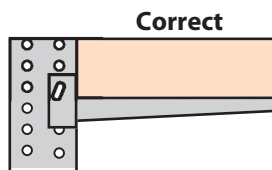

Figure B1

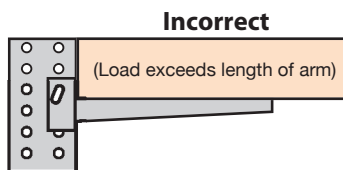

Figure B2

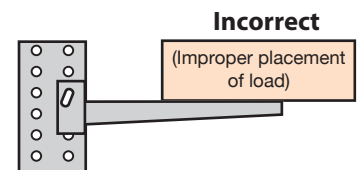

Figure B3

NOTE: All arm capacities are based on an evenly distributed load as in figures B4 and B5 below.

Evenly Distributed Load (front to back)
Full rated arm capacity

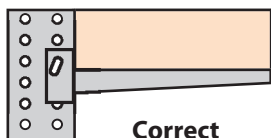

Figure B4

Centered Load
Full rated arm capacity

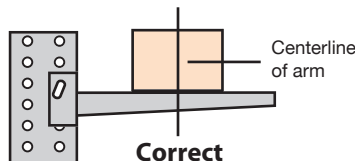

Figure B5

Tip Loading
Arm capacity may be reduced by up to 50%



Figure B6



C. DETERMINE THE HEIGHT OF THE UPRIGHT

When determining the height of the upright it is important to consider the ceiling height, forklift reach, sprinkler systems and other factors, such as local building codes that might affect the overall height.

The height of the upright in figure C1 is determined by adding the base height, the number of loads to be stored, the arm thickness plus 6" clearance between the load and next arm. Contact your MECO OMAHA sales professional for various rack dimensions such as base height and arm thickness.

IMPORTANT: The load placed on the base does not diminish the rated capacity of the upright. Thus, the heaviest loads should be placed on the base.

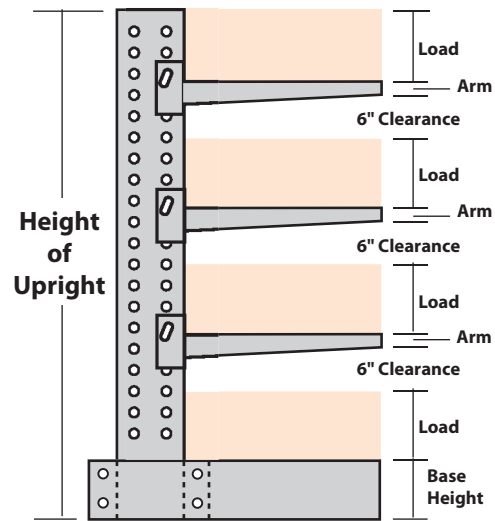

Figure C1

D. DETERMINE ARM AND UPRIGHT CAPACITIES

As previously discussed, each arm supports an equal amount of the load's weight. By determining the number of arms per level and dividing it into the weight per level, the required arm capacity can be determined (see example at right).

To determine the required capacity of each upright, multiply the number of arms per side by the load on each arm. In figure D1, each arm holds 2500 lbs. Twelve arms per side times 2500 lbs. per arm equals 30,000 lbs., which when divided by three uprights, results in a required minimum capacity of 10,000 lbs. per upright.

The correct upright can be selected by matching the minimum upright capacity of 10,000 lbs. with the upright capacities set forth on the following pages. Assuming a 48" arm, the U1061-NS on page 26 with 10,200 lbs. capacity and the U1061 on page 27 with 12,600 lbs. capacity are the only uprights that will handle the load. NOTE: The Series 1000 MU1057 has only 3100 lbs. capacity while the Series 2000 2U1062 has 8600 lbs. capacity.

The proper 48" arm (requiring 2500 lbs. of capacity) can be found on page 28: either the XHDSA48 at 2500 lbs. or the XHDSA483M at 3000 lbs. capacity.

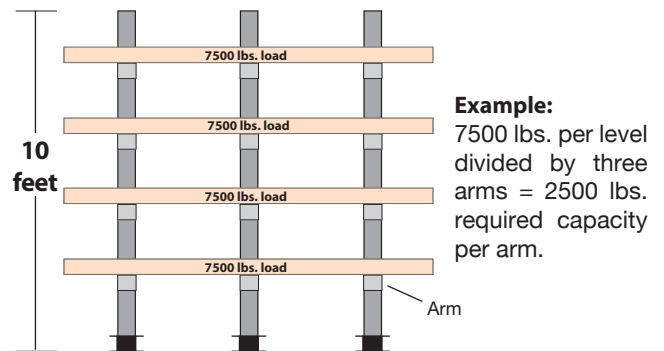

Figure D1

NOTE: Total arm capacity must never exceed total upright capacity.

E. DETERMINE BRACE LENGTH

Brace length is defined as the horizontal distance from centerline of upright to centerline of the next upright. Refer

to the various brace set charts for the brace length that most closely matches the arm spacing determined in step A.

The following pages set forth MECO OMAHA's wide range of cantilever racks – beginning with the Series 1000 Medium Duty on page 24 through the Series 5000 Extra Heavy Duty on page 28. MECO OMAHA representatives will work with you to develop the most feasible and economical rack system for your unique situation.



SERIES 1000 MEDIUM DUTY CANTILEVER RACK

EXCELLENT LOW COST STORAGE SYSTEM • IDEAL FOR MAINTENANCE DEPARTMENTS AND TOOL ROOMS

High quality **MECO OMAHA** Series 1000 Cantilever Rack is designed for use where heavier capacities are not required. This rack is similar to our popular heavier duty racks except for the use of lighter gauge steel and smaller dimensions of component parts. Available in 6', 7', 8', 10' and 12' single and double sided uprights with a choice of eight standard brace lengths (measured on center) to accommodate 12", 18", 24", 30", 36", 42" and 48" straight or inclined arms. Arms are completely adjustable on 3" centers up and down the full length of the uprights. Two or more uprights can be assembled into a continuous system.

This sturdy and stable rack is as convenient and versatile as the heavier duty racks but priced lower to reflect the reduced capacity. Installation is quick and easy. Racks can be tailored to your individual requirements. Uprights facilitate manual loading and unloading. Open base design affords easy forklift accessibility. Ideal for storing bar stock, pipe, tubing, lumber and many lightweight or hard-to-stock items that must be kept off the floor.



- EASY LOADING AND UNLOADING
- EVERY ITEM READILY AVAILABLE
- ALL WEIGHTS INCLUDE HARDWARE

MECO OMAHA SERIES 1000 UPRIGHTS, ARMS and BRACE SETS are not interchangeable with any other rack series.

SINGLE SIDED UPRIGHTS					
HEIGHT OF UPRIGHT	LENGTH OF BASE	LENGTH OF ARM	WEIGHT (LBS)	CAPACITY (LBS)	MODEL NO.
6'	33"	12" & 18"	82	8,100 & 6,600	MU633
	33"	24"	82	5,500	MU633
	45"	30"	90	4,700	MU645
	45"	36"	90	4,100	MU645
	57"	42" & 48"	100	3,700 & 3,300	MU657
7'	33"	12" & 18"	89	7,900 & 6,400	MU733
	33"	24"	89	5,300	MU733
	45"	30"	97	4,600	MU745
	45"	36"	97	4,100	MU745
	57"	42" & 48"	107	3,700 & 3,300	MU757
8'	33"	12" & 18"	96	7,600 & 6,300	MU833
	33"	24"	96	5,300	MU833
	45"	30"	104	4,500	MU845
	45"	36"	104	4,000	MU845
	57"	42" & 48"	114	3,600 & 3,200	MU857
10'	33"	12" & 18"	110	7,100 & 5,900	MU1033
	33"	24"	110	5,000	MU1033
	45"	30"	118	4,400	MU1045
	45"	36"	118	3,800	MU1045
	57"	42" & 48"	128	3,400 & 3,100	MU1057
12'	33"	12" & 18"	124	6,500 & 5,400	MU1233
	33"	24"	124	4,700	MU1233
	45"	30"	132	4,100	MU1245
	45"	36"	132	3,700	MU1245
	57"	42" & 48"	142	3,300 & 3,000	MU1257

DOUBLE SIDED UPRIGHTS					
HEIGHT OF UPRIGHT	LENGTH OF BASE	LENGTH OF ARM	WEIGHT (LBS)	CAPACITY (LBS)	MODEL NO.
6'	54"	12" & 18"	99	16,200 & 13,200	MDU654
	54"	24"	99	11,000	MDU654
	78"	30"	115	9,400	MDU678
	78"	36"	115	8,200	MDU678
	102"	42" & 48"	135	7,400 & 6,600	MDU6102
7'	54"	12" & 18"	106	15,800 & 12,800	MDU754
	54"	24"	106	10,600	MDU754
	78"	30"	122	9,200	MDU778
	78"	36"	122	8,200	MDU778
	102"	42" & 48"	142	7,400 & 6,600	MDU7102
8'	54"	12" & 18"	113	15,200 & 12,600	MDU854
	54"	24"	113	10,600	MDU854
	78"	30"	129	9,000	MDU878
	78"	36"	129	8,000	MDU878
	102"	42" & 48"	149	7,200 & 6,400	MDU8102
10'	54"	12" & 18"	127	14,200 & 11,800	MDU1054
	54"	24"	127	10,000	MDU1054
	78"	30"	143	8,800	MDU1078
	78"	36"	143	7,600	MDU1078
	102"	42" & 48"	163	6,800 & 6,200	MDU10102
12'	54"	12" & 18"	141	13,000 & 10,800	MDU1254
	54"	24"	141	9,400	MDU1254
	78"	30"	157	8,200	MDU1278
	78"	36"	157	7,400	MDU1278
	102"	42" & 48"	177	6,600 & 6,000	MDU12102

STRAIGHT ARMS				
LENGTH	CAPACITY	WEIGHT	MODEL NO. WITHOUT LIP	MODEL NO. WITH LIP
12"	1000 lbs	6 lbs	MSA12	MSA12L
18"	750 lbs	7 lbs	MSA18	MSA18L
24"	600 lbs	8 lbs	MSA24	MSA24L
30"	500 lbs	9 lbs	MSA30	MSA30L
36"	400 lbs	10 lbs	MSA36	MSA36L
42"	350 lbs	13 lbs	MSA42	MSA42L
48"	300 lbs	15 lbs	MSA48	MSA48L

INCLINED ARMS				
LENGTH	CAPACITY	WEIGHT	MODEL NO. WITHOUT LIP	MODEL NO. WITH LIP
12"	1000 lbs	6 lbs	MIA12	MIA12L
18"	750 lbs	7 lbs	MIA18	MIA18L
24"	600 lbs	8 lbs	MIA24	MIA24L
30"	500 lbs	9 lbs	MIA30	MIA30L
36"	400 lbs	10 lbs	MIA36	MIA36L
42"	350 lbs	13 lbs	MIA42	MIA42L
48"	300 lbs	15 lbs	MIA48	MIA48L

STRAIGHT ARMS have a minimum pitch of 3/8" per foot to compensate for deflection. Arm capacities are based on an evenly distributed load.

INCLINED ARMS have a pitch of 20 degrees or approximately 4.36" per foot. Arm capacities are based on an evenly distributed load.

NOTE: Arm lips are not intended to bear any portion of the load.

LENGTH*	BRACES FOR 6' - 10' UPRIGHTS - SET OF TWO		BRACES FOR 12' UPRIGHTS - SET OF THREE	
	MODEL NO.	WEIGHT	MODEL NO.	WEIGHT
23"	M2B24	21 lbs	M3B24	31 lbs
35"	M2B36	28 lbs	M3B36	41 lbs
41"	M2B42	31 lbs	M3B42	47 lbs
47"	M2B48	35 lbs	M3B48	52 lbs
59"	M2B60	42 lbs	M3B60	62 lbs
71"	M2B72	49 lbs	M3B72	73 lbs
83"	M2B84	56 lbs	M3B84	83 lbs
95"	M2B96	63 lbs	M3B96	94 lbs

* Length of braces is measured from center of upright to center of upright.



SERIES 2000 MEDIUM-HEAVY DUTY CANTILEVER RACK

MECO OMAHA SERIES 2000 UPRIGHTS, ARMS and BRACE SETS are not interchangeable with any other rack series.

SINGLE SIDED UPRIGHTS					
HEIGHT OF UPRIGHT	LENGTH OF BASE	LENGTH OF ARM	WEIGHT (LBS)	CAPACITY (LBS)	MODEL NO.
8'	38"	12" & 18"	188	18,100 & 15,300	2U838
	38"	24"	188	13,300	2U838
	50"	30" & 36"	201	11,800 & 10,600	2U850
	62"	42" & 48"	215	9,600 & 8,800	2U862
10'	38"	12" & 18"	217	17,400 & 14,900	2U1038
	38"	24"	217	13,100	2U1038
	50"	30" & 36"	230	11,500 & 10,300	2U1050
	62"	42" & 48"	244	9,400 & 8,600	2U1062
12'	38"	12" & 18"	245	16,800 & 14,500	2U1238
	38"	24"	245	12,600	2U1238
	50"	30" & 36"	258	11,200 & 10,200	2U1250
	62"	42" & 48"	272	9,300 & 8,500	2U1262
14'	38"	12" & 18"	272	16,200 & 14,100	2U1438
	38"	24"	272	12,300	2U1438
	50"	30" & 36"	285	10,900 & 9,800	2U1450
	62"	42" & 48"	299	8,900 & 8,300	2U1462
16'	38"	12" & 18"	299	15,800 & 13,800	2U1638
	38"	24"	299	12,100	2U1638
	50"	30" & 36"	312	10,600 & 9,400	2U1650
	62"	42" & 48"	326	8,400 & 7,500	2U1662
18'	38"	12" & 18"	326	15,700 & 13,700	2U1838
	38"	24"	326	11,900	2U1838
	50"	30" & 36"	339	10,400 & 9,200	2U1850
	62"	42" & 48"	353	8,200 & 7,400	2U1862
20'	38"	12" & 18"	353	15,600 & 13,600	2U2038
	38"	24"	353	11,700	2U2038
	50"	30" & 36"	366	10,200 & 9,000	2U2050
	62"	42" & 48"	380	8,100 & 7,300	2U2062

DOUBLE SIDED UPRIGHTS					
HEIGHT OF UPRIGHT	LENGTH OF BASE	LENGTH OF ARM	WEIGHT (LBS)	CAPACITY (LBS)	MODEL NO.
8'	59"	12" & 18"	216	36,200 & 30,600	2DU859
	59"	24"	216	26,600	2DU859
	83"	30" & 36"	243	23,600 & 21,200	2DU883
	107"	42" & 48"	270	19,200 & 17,600	2DU8107
10'	59"	12" & 18"	245	34,800 & 29,800	2DU1059
	59"	24"	245	26,200	2DU1059
	83"	30" & 36"	272	23,000 & 20,600	2DU1083
	107"	42" & 48"	299	18,800 & 17,200	2DU10107
12'	59"	12" & 18"	273	33,600 & 29,000	2DU1259
	59"	24"	273	25,200	2DU1259
	83"	30" & 36"	300	22,400 & 20,400	2DU1283
	107"	42" & 48"	327	18,600 & 17,000	2DU12107
14'	59"	12" & 18"	300	32,400 & 28,200	2DU1459
	59"	24"	300	24,600	2DU1459
	83"	30" & 36"	327	21,800 & 19,600	2DU1483
	107"	42" & 48"	354	17,800 & 16,600	2DU14107
16'	59"	12" & 18"	327	31,600 & 27,600	2DU1659
	59"	24"	327	24,200	2DU1659
	83"	30" & 36"	354	21,200 & 18,800	2DU1683
	107"	42" & 48"	381	16,800 & 15,000	2DU16107
18'	59"	12" & 18"	354	31,400 & 27,400	2DU1859
	59"	24"	354	23,800	2DU1859
	83"	30" & 36"	381	20,800 & 18,400	2DU1883
	107"	42" & 48"	408	16,400 & 14,800	2DU18107
20'	59"	12" & 18"	381	31,200 & 27,200	2DU2059
	59"	24"	381	23,400	2DU2059
	83"	30" & 36"	408	20,400 & 18,000	2DU2083
	107"	42" & 48"	435	16,200 & 14,600	2DU20107

STRAIGHT ARMS				
LENGTH	CAPACITY	WEIGHT	MODEL NO. WITHOUT LIP	MODEL NO. WITH LIP
12"	2000 lbs	7 lbs	2SA12	2SA12L
18"	1500 lbs	8 lbs	2SA18	2SA18L
24"	1200 lbs	9 lbs	2SA24	2SA24L
30"	1000 lbs	10 lbs	2SA30	2SA30L
36"	800 lbs	11 lbs	2SA36	2SA36L
42"	700 lbs	14 lbs	2SA42	2SA42L
48"	600 lbs	16 lbs	2SA48	2SA48L

INCLINED ARMS				
LENGTH	CAPACITY	WEIGHT	MODEL NO. WITHOUT LIP	MODEL NO. WITH LIP
12"	2000 lbs	7 lbs	2IA12	2IA12L
18"	1500 lbs	8 lbs	2IA18	2IA18L
24"	1200 lbs	9 lbs	2IA24	2IA24L
30"	1000 lbs	10 lbs	2IA30	2IA30L
36"	800 lbs	11 lbs	2IA36	2IA36L
42"	700 lbs	14 lbs	2IA42	2IA42L
48"	600 lbs	16 lbs	2IA48	2IA48L

STRAIGHT ARMS have a minimum pitch of 3/8" per foot to compensate for deflection. Arm capacities are based on an evenly distributed load.

INCLINED ARMS have a pitch of 20 degrees or approximately 4.36" per foot. Arm capacities are based on an evenly distributed load.

Note that arm lips are not intended to bear any portion of the load.



Single Sided Uprights

HEAVY DUTY AND EXTRA HEAVY DUTY STRAIGHT ARMS				
LENGTH	CAPACITY	WEIGHT	MODEL NO. WITHOUT LIP	MODEL NO. WITH LIP
24"	2400 lbs	14 lbs	2HDSA24	2HDSA24L
30"	2000 lbs	16 lbs	2HDSA30	2HDSA30L
36"	1500 lbs	18 lbs	2HDSA36	2HDSA36L
	2400 lbs	23 lbs	2XHDSA36	2XHDSA36L
42"	1400 lbs	20 lbs	2HDSA42	2HDSA42L
	2400 lbs	26 lbs	2XHDSA42	2XHDSA42L
48"	1000 lbs	21 lbs	2HDSA481M	2HDSA481M
	1500 lbs	24 lbs	2HDSA48	2HDSA48L
	2000 lbs	29 lbs	2XHDSA48	2XHDSA48L



Double Sided Uprights

LENGTH*	BRACES FOR 8' UPRIGHTS – SET OF TWO		BRACES FOR 10' - 14' UPRIGHTS – SET OF THREE		BRACES FOR 16' - 20' UPRIGHTS – SET OF FOUR INCLUDING X-BRACING	
	MODEL NO.	WEIGHT	MODEL NO.	WEIGHT	MODEL NO.	WEIGHT
23"	22B24	21 lbs	23B24	31 lbs	24B24X	66 lbs
35"	22B36	28 lbs	23B36	41 lbs	24B36X	81 lbs
41"	22B42	31 lbs	23B42	47 lbs	24B42X	90 lbs
47"	22B48	35 lbs	23B48	52 lbs	24B48X	97 lbs
59"	22B60	42 lbs	23B60	62 lbs	24B60X	113 lbs
71"	22B72	49 lbs	23B72	73 lbs	24B72X	130 lbs
83"	22B84	56 lbs	23B84	83 lbs	24B84X	147 lbs
95"	22B96	63 lbs	23B96	94 lbs	24B96XX	182 lbs
119"	22B120	113 lbs	23B120	170 lbs	24B120XX	283 lbs

* Length of braces is measured from center of upright to center of upright.

ALL WEIGHTS INCLUDE HARDWARE



MODERN EQUIPMENT COMPANY, INC.

OMAHA

SERIES 3000 HEAVY DUTY CANTILEVER RACK

UPRIGHTS

FOR YOUR NORMAL INDUSTRIAL STORAGE REQUIREMENTS

SINGLE SIDED UPRIGHTS						DOUBLE SIDED UPRIGHTS					
HEIGHT OF UPRIGHT	LENGTH OF BASE	LENGTH OF ARM	WEIGHT (LBS)	CAPACITY (LBS)	MODEL NO.	HEIGHT OF UPRIGHT	LENGTH OF BASE	LENGTH OF ARM	WEIGHT (LBS)	CAPACITY (LBS)	MODEL NO.
8'	31"	12" & 18"	217	23,000 & 19,200	U831-NS	8'	53"	12" & 18"	253	46,000 & 38,400	DU853-NS
	37"	24"	225	16,500	U837-NS		65"	24"	270	33,000	DU865-NS
	49"	30"	243	14,400	U849-NS		82"	30"	295	28,800	DU882-NS
	49"	36"	243	12,800	U849-NS		82"	36"	295	25,600	DU882-NS
	61"	42"	261	11,500	U861-NS		106"	42"	329	23,000	DU8106-NS
	61"	48"	261	10,400	U861-NS		106"	48"	329	20,800	DU8106-NS
74"	54" & 60"	279	9,600 & 8,800	U874-NS	130"	54" & 60"	364	19,200 & 17,600	DU8130-NS		
10'	31"	12" & 18"	255	22,200 & 18,600	U1031-NS	10'	53"	12" & 18"	291	44,400 & 37,200	DU1053-NS
	37"	24"	263	16,100	U1037-NS		65"	24"	308	32,200	DU1065-NS
	49"	30"	281	14,100	U1049-NS		82"	30"	333	28,200	DU1082-NS
	49"	36"	281	12,500	U1049-NS		82"	36"	333	25,000	DU1082-NS
	61"	42"	299	11,300	U1061-NS		106"	42"	367	22,600	DU10106-NS
	61"	48"	299	10,200	U1061-NS		106"	48"	367	20,400	DU10106-NS
74"	54" & 60"	317	9,400 & 8,700	U1074-NS	130"	54" & 60"	402	18,800 & 17,400	DU10130-NS		
12'	31"	12" & 18"	291	21,300 & 18,000	U1231-NS	12'	53"	12" & 18"	327	42,600 & 36,000	DU1253-NS
	37"	24"	299	15,600	U1237-NS		65"	24"	344	31,200	DU1265-NS
	49"	30"	317	13,700	U1249-NS		82"	30"	369	27,400	DU1282-NS
	49"	36"	317	12,200	U1249-NS		82"	36"	369	24,400	DU1282-NS
	61"	42"	335	11,000	U1261-NS		106"	42"	403	22,000	DU12106-NS
	61"	48"	335	10,100	U1261-NS		106"	48"	403	20,200	DU12106-NS
74"	54" & 60"	353	9,200 & 8,600	U1274-NS	130"	54" & 60"	438	18,400 & 17,200	DU12130-NS		
14'	37"	12" & 18"	338	20,500 & 17,400	U1437-NS	14'	65"	12" & 18"	382	41,000 & 34,800	DU1465-NS
	37"	24"	338	15,100	U1437-NS		82"	24"	382	30,200	DU1465-NS
	49"	30"	356	13,300	U1449-NS		82"	30"	407	26,600	DU1482-NS
	49"	36"	356	11,800	U1449-NS		82"	36"	407	23,600	DU1482-NS
	61"	42"	373	10,700	U1461-NS		106"	42"	442	21,400	DU14106-NS
	61"	48"	373	9,800	U1461-NS		106"	48"	442	19,600	DU14106-NS
74"	54" & 60"	391	9,000 & 8,300	U1474-NS	130"	54" & 60"	476	18,000 & 16,600	DU14130-NS		
15'	37"	12" & 18"	358	20,000 & 17,100	U1537-NS	15'	65"	12" & 18"	402	40,000 & 34,200	DU1565-NS
	37"	24"	358	14,800	U1537-NS		82"	24"	402	29,600	DU1565-NS
	49"	30"	375	13,200	U1549-NS		82"	30"	427	26,400	DU1582-NS
	49"	36"	375	11,600	U1549-NS		82"	36"	427	23,200	DU1582-NS
	61"	42"	393	10,500	U1561-NS		106"	42"	462	21,000	DU15106-NS
	61"	48"	393	9,700	U1561-NS		106"	48"	462	19,400	DU15106-NS
74"	54" & 60"	411	8,900 & 8,300	U1574-NS	130"	54" & 60"	496	17,800 & 16,600	DU15130-NS		
16'	37"	12" & 18"	376	19,300 & 16,600	U1637-NS	16'	65"	12" & 18"	420	38,600 & 33,200	DU1665-NS
	37"	24"	376	14,400	U1637-NS		82"	24"	420	28,800	DU1665-NS
	49"	30"	393	12,800	U1649-NS		82"	30"	445	25,600	DU1682-NS
	49"	36"	393	11,300	U1649-NS		82"	36"	445	22,600	DU1682-NS
	61"	42"	411	10,400	U1661-NS		106"	42"	479	20,800	DU16106-NS
	61"	48"	411	9,500	U1661-NS		106"	48"	479	19,000	DU16106-NS
74"	54" & 60"	429	8,800 & 8,200	U1674-NS	130"	54" & 60"	514	17,600 & 16,400	DU16130-NS		
18'	49"	12" & 18"	429	18,200 & 15,600	U1849-NS	18'	82"	12" & 18"	480	36,400 & 31,200	DU1882-NS
	49"	24"	429	13,800	U1849-NS		82"	24"	480	27,600	DU1882-NS
	49"	30"	429	12,300	U1849-NS		82"	30"	480	24,600	DU1882-NS
	49"	36"	429	10,800	U1849-NS		82"	36"	480	21,600	DU1882-NS
	61"	42"	446	9,900	U1861-NS		106"	42"	515	19,800	DU18106-NS
	61"	48"	446	9,200	U1861-NS		106"	48"	515	18,400	DU18106-NS
74"	54" & 60"	464	8,500 & 8,000	U1874-NS	130"	54" & 60"	549	17,000 & 16,000	DU18130-NS		
20'	49"	12" & 18"	464	16,700 & 14,600	U2049-NS	20'	82"	12" & 18"	516	33,400 & 29,200	DU2082-NS
	49"	24"	464	12,900	U2049-NS		82"	24"	516	25,800	DU2082-NS
	49"	30"	464	11,700	U2049-NS		82"	30"	516	23,400	DU2082-NS
	49"	36"	464	10,400	U2049-NS		82"	36"	516	20,800	DU2082-NS
	61"	42"	481	9,400	U2061-NS		106"	42"	550	18,800	DU20106-NS
	61"	48"	481	8,800	U2061-NS		106"	48"	550	17,600	DU20106-NS
74"	54" & 60"	500	8,100 & 7,600	U2074-NS	130"	54" & 60"	584	16,200 & 15,200	DU20130-NS		

A MECO OMAHA rack system can be specifically designed to meet your individual requirements. MECO OMAHA representatives will work with you to develop the most feasible and economical rack system for your special situation.

BRACE SETS

All braces can be used on SERIES 3000, SERIES 4000 or SERIES 5000 uprights only.

LENGTH*	FOR 8' UPRIGHTS SET OF TWO		FOR 10' - 14' UPRIGHTS SET OF THREE		FOR 15' - 20' UPRIGHTS SET OF FOUR INCLUDING X-BRACING	
	MODEL NO.	WEIGHT	MODEL NO.	WEIGHT	MODEL NO.	WEIGHT
24"	2B24	21 lbs	3B24	31 lbs	4B24X	66 lbs
36"	2B36	28 lbs	3B36	41 lbs	4B36X	81 lbs
42"	2B42	31 lbs	3B42	47 lbs	4B42X	90 lbs
48"	2B48	35 lbs	3B48	52 lbs	4B48X	97 lbs
60"	2B60	42 lbs	3B60	62 lbs	4B60X	113 lbs
72"	2B72	49 lbs	3B72	73 lbs	4B72X	130 lbs
84"	2B84	56 lbs	3B84	83 lbs	4B84X	147 lbs
96"	2B96	63 lbs	3B96	94 lbs	4B96XX	182 lbs
120"	2B120	113 lbs	3B120	170 lbs	4B120XX	283 lbs

*Length of braces is measured from center of upright to center of upright.

ALL WEIGHTS INCLUDE HARDWARE





SERIES 4000 STANDARD HEAVY DUTY CANTILEVER RACK UPRIGHTS

FOR YOUR NORMAL HEAVY DUTY INDUSTRIAL STORAGE REQUIREMENTS

SINGLE SIDED UPRIGHTS						DOUBLE SIDED UPRIGHTS					
HEIGHT OF UPRIGHT	LENGTH OF BASE	LENGTH OF ARM	WEIGHT (LBS)	CAPACITY (LBS)	MODEL NO.	HEIGHT OF UPRIGHT	LENGTH OF BASE	LENGTH OF ARM	WEIGHT (LBS)	CAPACITY (LBS)	MODEL NO.
8'	31"	12" & 18"	237	28,600 & 24,700	U831	8'	53"	12" & 18"	273	57,200 & 49,400	DU853
	37"	24"	245	21,500	U837		65"	24"	290	43,000	DU865
	49"	30"	263	18,300	U849		82"	30"	315	36,600	DU882
	49"	36"	263	16,000	U849		82"	36"	315	32,000	DU882
	61"	42"	281	14,200	U861		106"	42"	349	28,400	DU8106
	61"	48"	281	12,800	U861		106"	48"	349	25,600	DU8106
	74"	54" & 60"	299	11,600 & 10,700	U874		130"	54" & 60"	384	23,200 & 21,400	DU8130
10'	31"	12" & 18"	275	28,500 & 24,600	U1031	10'	53"	12" & 18"	311	57,000 & 49,200	DU1053
	37"	24"	283	21,300	U1037		65"	24"	328	42,600	DU1065
	49"	30"	301	18,200	U1049		82"	30"	353	36,400	DU1082
	49"	36"	301	15,800	U1049		82"	36"	353	31,600	DU1082
	61"	42"	319	14,100	U1061		106"	42"	387	28,200	DU10106
	61"	48"	319	12,600	U1061		106"	48"	387	25,200	DU10106
	74"	54" & 60"	337	11,500 & 10,600	U1074		130"	54" & 60"	422	23,000 & 21,200	DU10130
12'	31"	12" & 18"	311	28,200 & 24,400	U1231	12'	53"	12" & 18"	347	56,400 & 48,800	DU1253
	37"	24"	319	20,900	U1237		65"	24"	364	41,800	DU1265
	49"	30"	337	17,800	U1249		82"	30"	389	35,600	DU1282
	49"	36"	337	15,600	U1249		82"	36"	389	31,200	DU1282
	61"	42"	355	13,900	U1261		106"	42"	423	27,800	DU12106
	61"	48"	355	12,500	U1261		106"	48"	423	25,000	DU12106
	74"	54" & 60"	373	11,400 & 10,500	U1274		130"	54" & 60"	458	22,800 & 21,000	DU12130
14'	37"	12" & 18"	358	27,400 & 23,400	U1437	14'	65"	12" & 18"	402	54,800 & 46,800	DU1465
	37"	24"	358	20,200	U1437		65"	24"	402	40,400	DU1465
	49"	30"	376	17,600	U1449		82"	30"	427	35,200	DU1482
	49"	36"	376	15,400	U1449		82"	36"	427	30,800	DU1482
	61"	42"	393	13,700	U1461		106"	42"	462	27,400	DU14106
	61"	48"	393	12,400	U1461		106"	48"	462	24,800	DU14106
	74"	54" & 60"	411	11,300 & 10,400	U1474		130"	54" & 60"	496	22,600 & 20,800	DU14130
15'	37"	12" & 18"	378	27,100 & 22,600	U1537	15'	65"	12" & 18"	422	54,200 & 45,200	DU1565
	37"	24"	378	19,200	U1537		65"	24"	422	38,400	DU1565
	49"	30"	395	16,900	U1549		82"	30"	447	33,800	DU1582
	49"	36"	395	15,000	U1549		82"	36"	447	30,000	DU1582
	61"	42"	413	13,600	U1561		106"	42"	482	27,200	DU15106
	61"	48"	413	12,300	U1561		106"	48"	482	24,600	DU15106
	74"	54" & 60"	431	11,200 & 10,300	U1574		130"	54" & 60"	516	22,400 & 20,600	DU15130
16'	37"	12" & 18"	396	23,700 & 20,300	U1637	16'	65"	12" & 18"	440	47,400 & 40,600	DU1665
	37"	24"	396	17,600	U1637		65"	24"	440	35,200	DU1665
	49"	30"	413	15,300	U1649		82"	30"	465	30,600	DU1682
	49"	36"	413	14,000	U1649		82"	36"	465	28,000	DU1682
	61"	42"	431	12,900	U1661		106"	42"	499	25,800	DU16106
	61"	48"	431	12,000	U1661		106"	48"	499	24,000	DU16106
	74"	54" & 60"	449	11,100 & 10,300	U1674		130"	54" & 60"	534	22,200 & 20,600	DU16130
18'	49"	12" & 18"	449	22,200 & 19,200	U1849	18'	82"	12" & 18"	500	44,400 & 38,400	DU1882
	49"	24"	449	16,700	U1849		82"	24"	500	33,400	DU1882
	49"	30"	449	14,700	U1849		82"	30"	500	29,400	DU1882
	49"	36"	449	13,600	U1849		82"	36"	500	27,200	DU1882
	61"	42"	466	12,700	U1861		106"	42"	535	25,400	DU18106
	61"	48"	466	11,900	U1861		106"	48"	535	23,800	DU18106
	74"	54" & 60"	484	11,000 & 10,000	U1874		130"	54" & 60"	569	22,000 & 20,000	DU18130
20'	49"	12" & 18"	484	20,600 & 17,800	U2049	20'	82"	12" & 18"	536	41,200 & 35,600	DU2082
	49"	24"	484	15,800	U2049		82"	24"	536	31,600	DU2082
	49"	30"	484	13,900	U2049		82"	30"	536	27,800	DU2082
	49"	36"	484	12,800	U2049		82"	36"	536	25,600	DU2082
	61"	42"	501	11,900	U2061		106"	42"	570	23,800	DU20106
	61"	48"	501	11,200	U2061		106"	48"	570	22,400	DU20106
	74"	54" & 60"	520	10,500 & 9,800	U2074		130"	54" & 60"	604	21,000 & 19,600	DU20130

A MECO OMAHA rack system can be specifically designed to meet your individual requirements. MECO OMAHA representatives will work with you to develop the most feasible and economical rack system for your special situation.

ARMS can be used on SERIES 3000, SERIES 4000 or SERIES 5000 uprights only. Capacities are based on an evenly distributed load. Note that arm lips are not intended to bear any portion of the load.

STANDARD STRAIGHT ARMS				
LENGTH	CAPACITY	WEIGHT	MODEL NO. WITHOUT LIP	MODEL NO. WITH LIP
12"	3000 lbs	9 lbs	SA12	SA12L
18"	2500 lbs	11 lbs	SA18	SA18L
24"	2000 lbs	13 lbs	SA24	SA24L
30"	1500 lbs	15 lbs	SA30	SA30L
36"	1200 lbs	17 lbs	SA36	SA36L
42"	1100 lbs	19 lbs	SA42	SA42L
48"	1000 lbs	21 lbs	SA48	SA48L
54"	800 lbs	24 lbs	SA54	SA54L
60"	600 lbs	26 lbs	SA60	SA60L

STRAIGHT ARMS through 48" long have a minimum pitch of 3/8" per foot to compensate for deflection. 54" and 60" arms have a minimum pitch of 5/8" per foot.

STANDARD INCLINED ARMS				
LENGTH	CAPACITY	WEIGHT	MODEL NO. WITHOUT LIP	MODEL NO. WITH LIP
12"	3000 lbs	9 lbs	IA12	IA12L
18"	2500 lbs	11 lbs	IA18	IA18L
24"	2000 lbs	13 lbs	IA24	IA24L
30"	1500 lbs	15 lbs	IA30	IA30L
36"	1200 lbs	17 lbs	IA36	IA36L
42"	1100 lbs	22 lbs	IA42	IA42L
48"	1000 lbs	23 lbs	IA48	IA48L

INCLINED ARMS have a pitch of 20 degrees or approximately 4.36" per foot.

ALL WEIGHTS INCLUDE HARDWARE

See page 28 for Heavy Duty and Extra Heavy Duty Straight Arms for use with uprights on pages 26 and 27.



SERIES 5000 EXTRA HEAVY DUTY CANTILEVER RACK

UPRIGHTS

FOR STORAGE REQUIREMENTS WHICH DEMAND HEAVIER CAPACITY RACKS

MECO OMAHA SERIES 5000 CANTILEVER RACK solves your extra heavy duty storage problems and easily handles your toughest storage requirements. Contact your MECO OMAHA representative for your special storage needs.

SINGLE SIDED UPRIGHTS					
HEIGHT OF UPRIGHT	LENGTH OF BASE	LENGTH OF ARM	WEIGHT (LBS)	CAPACITY (LBS)	MODEL NO.
12'	40"	24"	410	28,700	XU1240
	52"	30"	432	24,800	XU1252
	52"	36"	432	21,900	XU1252
	64"	42"	454	19,600	XU1264
	64"	48"	454	17,700	XU1264
	76"	54"	477	16,100	XU1276
	76"	60"	477	14,900	XU1276
14'	40"	24"	455	28,400	XU1440
	52"	30"	477	24,700	XU1452
	52"	36"	477	21,000	XU1452
	64"	42"	499	19,100	XU1464
	64"	48"	499	17,600	XU1464
	76"	54"	522	16,000	XU1476
	76"	60"	522	14,600	XU1476
15'	52"	24"	497	28,200	XU1552
	52"	30"	497	22,600	XU1552
	52"	36"	497	20,700	XU1552
	64"	42"	519	18,900	XU1564
	64"	48"	519	17,400	XU1564
	76"	54"	542	15,900	XU1576
	76"	60"	542	14,500	XU1576
16'	52"	24"	522	27,600	XU1652
	52"	30"	522	24,300	XU1652
	52"	36"	522	20,500	XU1652
	64"	42"	544	18,700	XU1664
	64"	48"	544	17,200	XU1664
	76"	54"	567	15,700	XU1676
	76"	60"	567	14,400	XU1676
18'	52"	24"	565	25,900	XU1852
	52"	30"	565	23,100	XU1852
	52"	36"	565	20,400	XU1852
	64"	42"	587	18,200	XU1864
	64"	48"	587	16,800	XU1864
	76"	54"	610	15,300	XU1876
	76"	60"	610	14,100	XU1876
20'	52"	24"	607	25,300	XU2052
	52"	30"	607	21,800	XU2052
	52"	36"	607	19,700	XU2052
	64"	42"	629	17,600	XU2064
	64"	48"	629	16,300	XU2064
	76"	54"	652	14,900	XU2076
	76"	60"	652	13,800	XU2076

DOUBLE SIDED UPRIGHTS					
HEIGHT OF UPRIGHT	LENGTH OF BASE	LENGTH OF ARM	WEIGHT (LBS)	CAPACITY (LBS)	MODEL NO.
12'	66"	24"	464	57,400	XDU1266
	84"	30"	498	49,600	XDU1284
	84"	36"	498	43,800	XDU1284
	108"	42"	542	39,200	XDU12108
	108"	48"	542	35,400	XDU12108
	132"	54"	586	32,200	XDU12132
	132"	60"	586	29,800	XDU12132
14'	66"	24"	509	56,800	XDU1466
	84"	30"	543	49,400	XDU1484
	84"	36"	543	42,000	XDU1484
	108"	42"	587	38,200	XDU14108
	108"	48"	587	35,200	XDU14108
	132"	54"	631	32,000	XDU14132
	132"	60"	631	29,200	XDU14132
15'	84"	24"	563	56,400	XDU1584
	84"	30"	563	45,200	XDU1584
	84"	36"	563	41,400	XDU1584
	108"	42"	607	37,800	XDU15108
	108"	48"	607	34,800	XDU15108
	132"	54"	651	31,800	XDU15132
	132"	60"	651	29,000	XDU15132
16'	84"	24"	588	55,200	XDU1684
	84"	30"	588	48,600	XDU1684
	84"	36"	588	41,000	XDU1684
	108"	42"	632	37,400	XDU16108
	108"	48"	632	34,400	XDU16108
	132"	54"	676	31,400	XDU16132
	132"	60"	676	28,800	XDU16132
18'	84"	24"	630	51,800	XDU1884
	84"	30"	630	46,200	XDU1884
	84"	36"	630	40,800	XDU1884
	108"	42"	674	36,400	XDU18108
	108"	48"	674	33,600	XDU18108
	132"	54"	719	30,600	XDU18132
	132"	60"	719	28,200	XDU18132
20'	84"	24"	673	50,600	XDU2084
	84"	30"	673	43,600	XDU2084
	84"	36"	673	39,400	XDU2084
	108"	42"	717	35,200	XDU20108
	108"	48"	717	32,600	XDU20108
	132"	54"	761	29,800	XDU20132
	132"	60"	761	27,600	XDU20132

ARMS can be used on SERIES 3000, SERIES 4000 or SERIES 5000 uprights only. Capacities are based on an evenly distributed load. Note that arm lips are not intended to bear any portion of the load.

HEAVY DUTY AND EXTRA HEAVY DUTY STRAIGHT ARMS				
LENGTH	CAPACITY	WEIGHT	MODEL NO. WITHOUT LIP	MODEL NO. WITH LIP
36"	2175 lbs	28 lbs	HDSA36	HDSA36L
	3400 lbs	34 lbs	XHDSA36	XHDSA36L
42"	1865 lbs	31 lbs	HDSA42	HDSA42L
	2900 lbs	37 lbs	XHDSA42	XHDSA42L
48"	1630 lbs	34 lbs	HDSA48	HDSA48L
	2000 lbs	36 lbs	HDSA482M	HDSA48L2M
	2500 lbs	40 lbs	XHDSA48	XHDSA48L
	3000 lbs	39 lbs	XHDSA483M	XHDSA48L3M
	4000 lbs	51 lbs	XHDSA484M	XHDSA48L4M
54"	1440 lbs	38 lbs	HDSA54	HDSA54L
	2000 lbs	44 lbs	XHDSA54	XHDSA54L
60"	1300 lbs	42 lbs	HDSA60	HDSA60L
	1650 lbs	46 lbs	XHDSA60	XHDSA60L
	2000 lbs	61 lbs	XHDSA602M	XHDSA60L2M

MAXIMUM STANDARD ARMS PER UPRIGHT (UPRIGHT CAPACITIES MUST BE OBSERVED)		
UPRIGHT	SINGLE UPRIGHT	DOUBLE UPRIGHT
8'	9	18
10'	12	24
12'	14	28
14'	17	34
15'	18	36
16'	20	40
18'	22	44
20'	24	48

ALL WEIGHTS INCLUDE HARDWARE

See pages 26 and 27 for Brace Sets, Standard Straight Arms and Standard Inclined Arms for use with Series 5000 uprights.



CANTILEVER RACK STARTER AND ADD-ON UNITS

A COMPLETE STORAGE SYSTEM DESIGNED WITH FLEXIBILITY AND SIMPLICITY IN MIND

MECO OMAHA has assembled the most popular Series 1000 and Series 4000 cantilever components to create Starter and Add-On units—take the guesswork out of selecting a rack system! Order a single or double sided starter unit consisting of 2 uprights, straight arms and braces to assemble a single bay storage unit.

Create a continuous rack system with add-on units which include 1 Series 1000 upright, straight arms and the appropriate brace set. Choose models in upright heights of 6', 8' or 10'. Series 4000 models are available in 8', 10' and 12' heights and easily handle lighter capacity requirements.

SERIES 1000 MEDIUM DUTY CANTILEVER RACK

STARTER UNITS								ADD-ON UNITS			
INCLUDES: 2 UPRIGHTS, STRAIGHT ARMS, 1 BRACE SET (47" BRACE SET FOR 6' AND 8' UPRIGHTS, 71" BRACE SET FOR 10' UPRIGHTS)								INCLUDES: 1 UPRIGHT, STRAIGHT ARMS, 1 BRACE SET (47" BRACE SET FOR 6' AND 8' UPRIGHTS, 71" BRACE SET FOR 10' UPRIGHTS)			
MODEL NO.	UPRIGHT		BASE	ARMS*			WEIGHT (LBS)	MODEL NO.	ARMS*		WEIGHT (LBS)
	HEIGHT (FT)	CAPACITY (LBS)	LENGTH (IN)	LENGTH (IN)	QUANTITY	CAPACITY (LBS)			LENGTH (IN)	QUANTITY	
SINGLE SIDED UNITS											
SM6	6	8,100	33	12	6	1,000	235	AM6	12	3	135
SM8	8	5,300	33	24	8	600	291	AM8	24	4	163
SM10	10	3,800	45	36	12	400	405	AM10	36	6	227
DOUBLE SIDED UNITS											
SMD6	6	16,200	54	12	12	1,000	305	AMD6	12	6	170
SMD8	8	10,600	54	24	16	600	389	AMD8	24	8	212
SMD10	10	7,600	78	36	24	400	575	AMD10	36	12	312

*Add Suffix "L" to Model Number for Arms with Lips.

SERIES 4000 STANDARD HEAVY DUTY CANTILEVER RACK

STARTER UNITS								ADD-ON UNITS			
INCLUDES: 2 UPRIGHTS, STRAIGHT ARMS, 6' BRACE SET								INCLUDES: 1 UPRIGHT, STRAIGHT ARMS, 6' BRACE SET			
MODEL NO.	UPRIGHT		BASE	ARMS*			WEIGHT (LBS)	MODEL NO.	ARMS*		WEIGHT (LBS)
	HEIGHT (FT)	CAPACITY (LBS)	LENGTH (IN)	LENGTH (IN)	QUANTITY	CAPACITY (LBS)			LENGTH (IN)	QUANTITY	
SINGLE SIDED UNITS											
SU8	8	21,500	37	24	8	2,000	643	AU8	24	4	346
SU10	10	15,800	49	36	12	1,200	879	AU10	36	6	476
SU12	12	12,500	61	48	16	1,000	1,119	AU12	48	8	596
DOUBLE SIDED UNITS											
SDU8	8	43,000	65	24	16	2,000	837	ADU8	24	8	443
SDU10	10	31,600	82	36	24	1,200	1,187	ADU10	36	12	630
SDU12	12	25,000	106	48	32	1,000	1,591	ADU12	48	16	832

* Add Suffix "L" to Model Number for Arms with Lips.

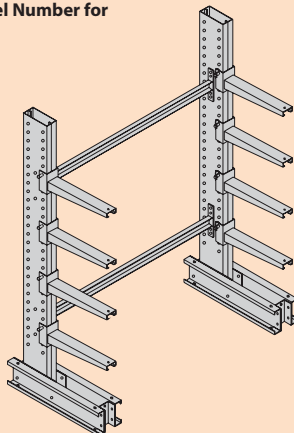

SU8
STARTER UNIT

AU8
ADD-ON UNIT

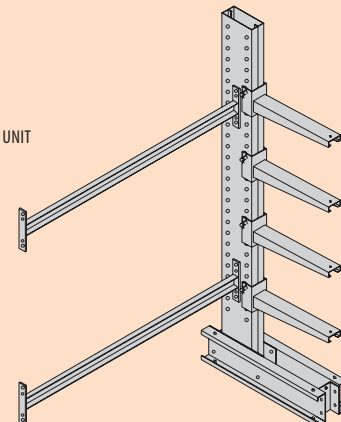



CANTILEVER RACK ACCESSORIES and HEAVYWEIGHT STRUCTURAL CANTILEVER RACK

Lip extends 2" above the arm surface

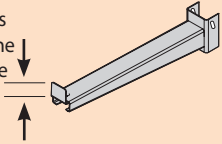

Bolt-On Arm Lips

All MECO OMAHA cantilever arms are factory punched to accept a bolt-on lip at any time. Lips can also be removed when they are no longer required. Lips are not intended to bear any portion of the load.

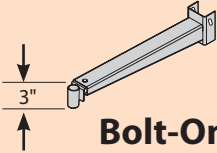

Bolt-On Pipe Sockets

Pipe sockets can be field installed or removed as needs dictate—just like bolt-on lips. Inside diameter of the socket is 1 3/8". Removable pipe is not included. Pipe sockets are not intended to bear any portion of the load.

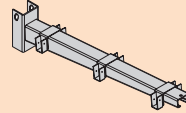

Drop-In Deck Support Saddles

Add a plywood deck to the cantilever system to store bulky items such as boxes, cartons and furniture. MECO OMAHA will pre-engineer the saddles to accommodate 2x4 cross supports. Saddles must be positioned along the arm to ensure equal distribution of weight. Deck support saddles can also be provided for the bases. Saddles must be fastened to the arms and bases. Field drilling is required. Fasteners are not included. Other saddle styles available. Please inquire.

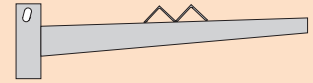

Welded Axle Cradles

Reels, spools and rolls can be stored between arms with the addition of axle cradles. Axle is not included.

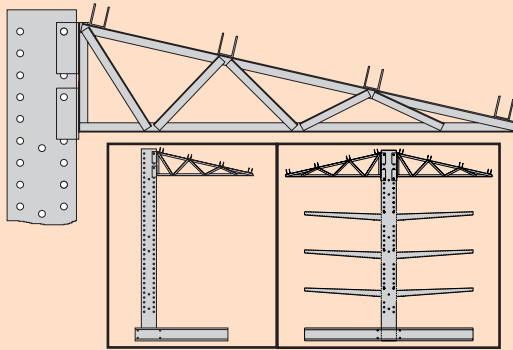

Single Sided Double Sided

Roof Supports

Turn a cantilever rack system into covered storage with MECO OMAHA roof supports. Can be used as single or double sided roof (depending on length of base used). Purlin clips included. **NOTE:** The use of roof supports can significantly reduce the rack's capacity due to wind and snow loads. MECO OMAHA will custom design the roof supports to conform with local wind and snow load conditions.

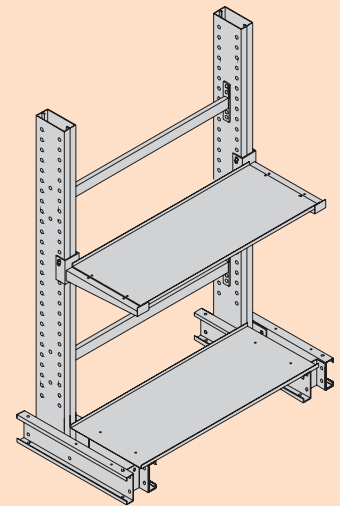

Steel Decks

MECO OMAHA offers optional steel decks to withstand the harshest industrial environment. Ideal for storage of short lengths of material, dies, castings and other items that require an uninterrupted length of heavy duty decking. Steel angles are welded to the underside of the deck for additional strength. Arms and decks are precision drilled to accept mounting hardware.

STRUCTURAL WIDE FLANGE UPRIGHTS

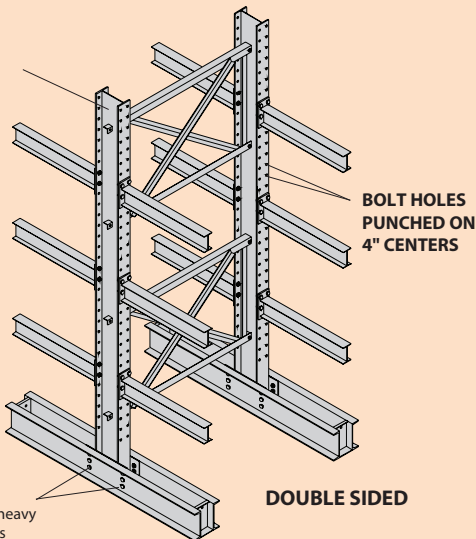

BOLT HOLES PUNCHED ON 4" CENTERS

STRUCTURAL BASE Attached to upright by heavy duty, high strength bolts

DOUBLE SIDED

Structural Cantilever Rack

Select a MECO OMAHA Structural Cantilever Rack system when your load requirements surpass normal capacities. Uprights are fabricated from rugged structural wide flange beams. Heights are available through 24 feet. Bolt holes are punched on 4" centers the full height of the upright. Both single sided and double sided uprights are available. Structural bases are attached to the uprights by heavy duty, high strength bolts. Load on bases does not affect the total upright capacity.



MECO OMAHA's 200,000 sq. ft. facility on ten acres of land in Omaha, Nebraska.



MODERN EQUIPMENT COMPANY, INC.

6161 Abbott Drive
Omaha, Nebraska 68110

PO Box 12278
Omaha, Nebraska 68112

E-mail: sales@meco-omaha.com • www.meco-omaha.com



LOCAL (402) 341-4939

ORDER TOLL FREE

1-800-228-7334

FAX 1-800-245-6078

WE NEVER MISS!
A PROMISED SHIPPING DATE